

Small Arms and Light Weapons Asia Pacific Security Project

Training, Operations and other Activity

James McColm, Technical Officer

WCO Security Programme

Passenger controls/FTFs
(API and PNR)

IEDs
(Global Shield)

Strategic Trade
(STCE Programme)

Small Arms and Light-Weapons
(SALW Project)

Terrorist financing



Training



1st Train the Trainer Sub Regional Event, Phnom Penh, Cambodia, 1 – 10 August, 2018





2nd Train the Trainer Sub Regional Event, Hanoi, Vietnam 3 – 14 December, 2018



3rd Train the Trainer Sub Regional Event, Manila, Philippines, 1 – 12 April, 2019

Training – Identify the Threat



Gunman walking through Chatrapati Shivaji Terminus Railway Station, Mumbai, India, November 26, 2008

ISIS Fighters before the invasion of Marawi, Philippines, May 2017



Training – Source of Weapons

Life cycle of a gun

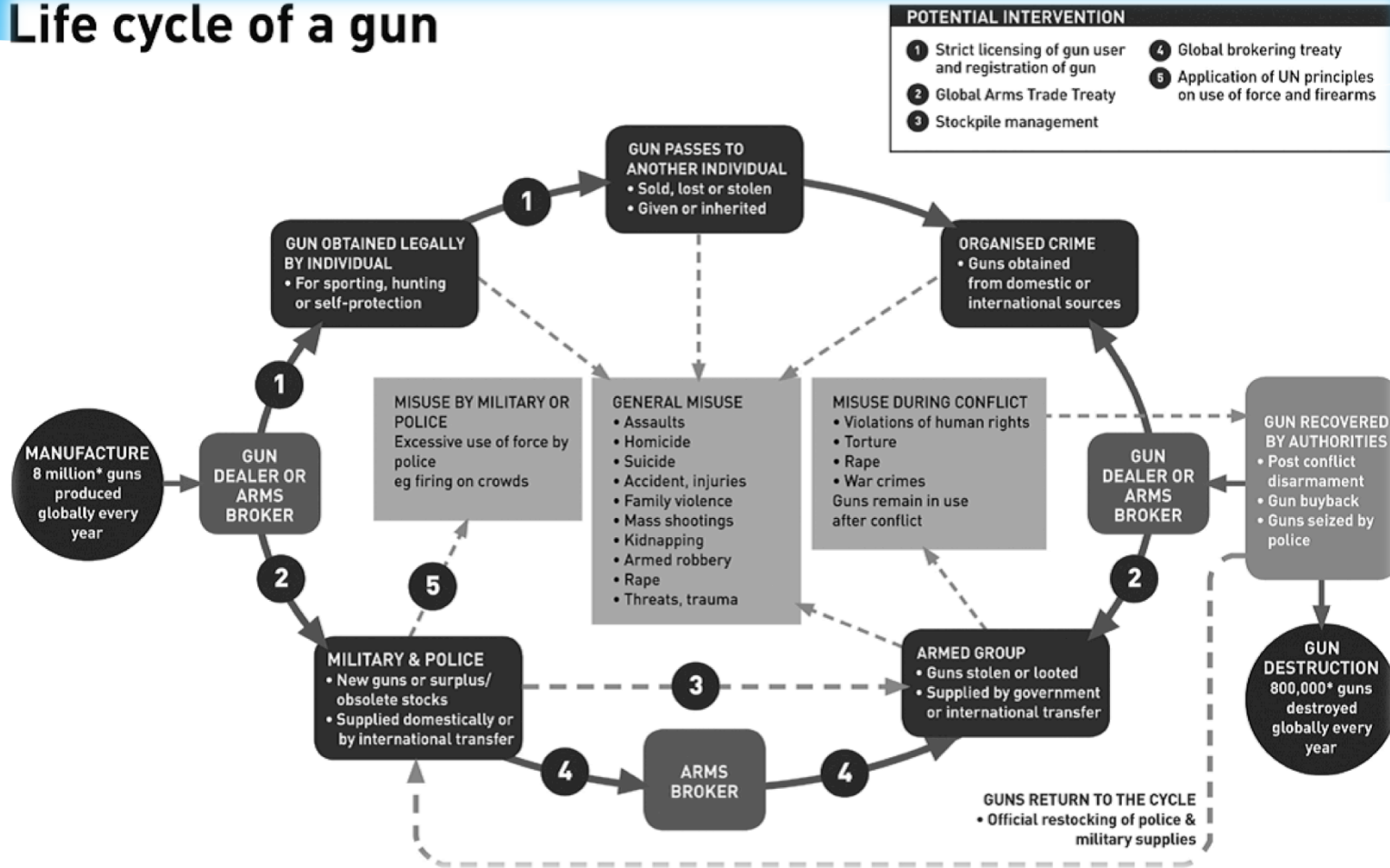

Training - International Legislation



World Customs Organization
Organisation Mondiale des Douanes

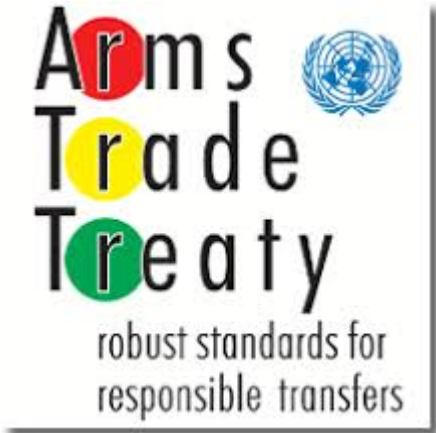

UNODA
UNITED NATIONS OFFICE FOR
DISARMAMENT AFFAIRS

Training - National Legislation



- * Examples of National Permits for Firearms, Philippines.

Training – Document Fraud, Counterfeit and Forgery

U.S. Department of Justice
Bureau of Alcohol, Tobacco, Firearms and Explosives

Federal Firearms License (18 U.S.C. Chapter 44)

In accordance with the provisions of Title I, Gun Control Act of 1968, and the regulations issued thereunder (27 CFR Part 478), you are licensed to engage in the business specified in this license, within the limitations of Chapter 44, Title 18, United States Code, and the regulations issued thereunder, until the expiration date shown. See "WARNINGS" and "NOTICES" on reverse.

Direct ATF ATF - Chief, FFLC
Correspondence To 2600 Century Parkway, NE Suite 110
 Atlanta, Georgia 30345-3104

Chief, Federal Firearms Licensing Center (FFLC)

Name
HALLOWELL & CO

Premises Address (Changes? Notify the FFLC if you move)
203 SKOWHEGAN
LIVINGSTON, MT 59000

Type of License
01-DEALER

The licensee named above certifies that he/she is the owner of the premises specified above and that he/she is qualified to engage in the business specified above under the provisions of the laws of the State of New York.

Mailing Address (Changes? Notify the FFLC of any changes.)
HALLOWELL & CO INC
HALLOWELL & CO
PO BOX 1445
LIVINGSTON, MT 59047-0000

License Number **9-81-067-01-1F-35513**

Expiration Date **1, 2001**

Licensee/Responsible Person Signature Position/Title

AMMOLAND

FAKE

UNRESTRICTED

C _____

Date _____

STATE OF NEW YORK

County of ORANGE

LICENSE TO CARRY PISTOL IS HEREBY GRANTED

To _____

Address _____

Occupation _____

Employed by _____

Nationality _____

Age _____ Height _____ Weight _____

Judge Orange County Court

Form P-4 Williamson Law Book Co., Rochester, N. Y. 14609

Training - Identification

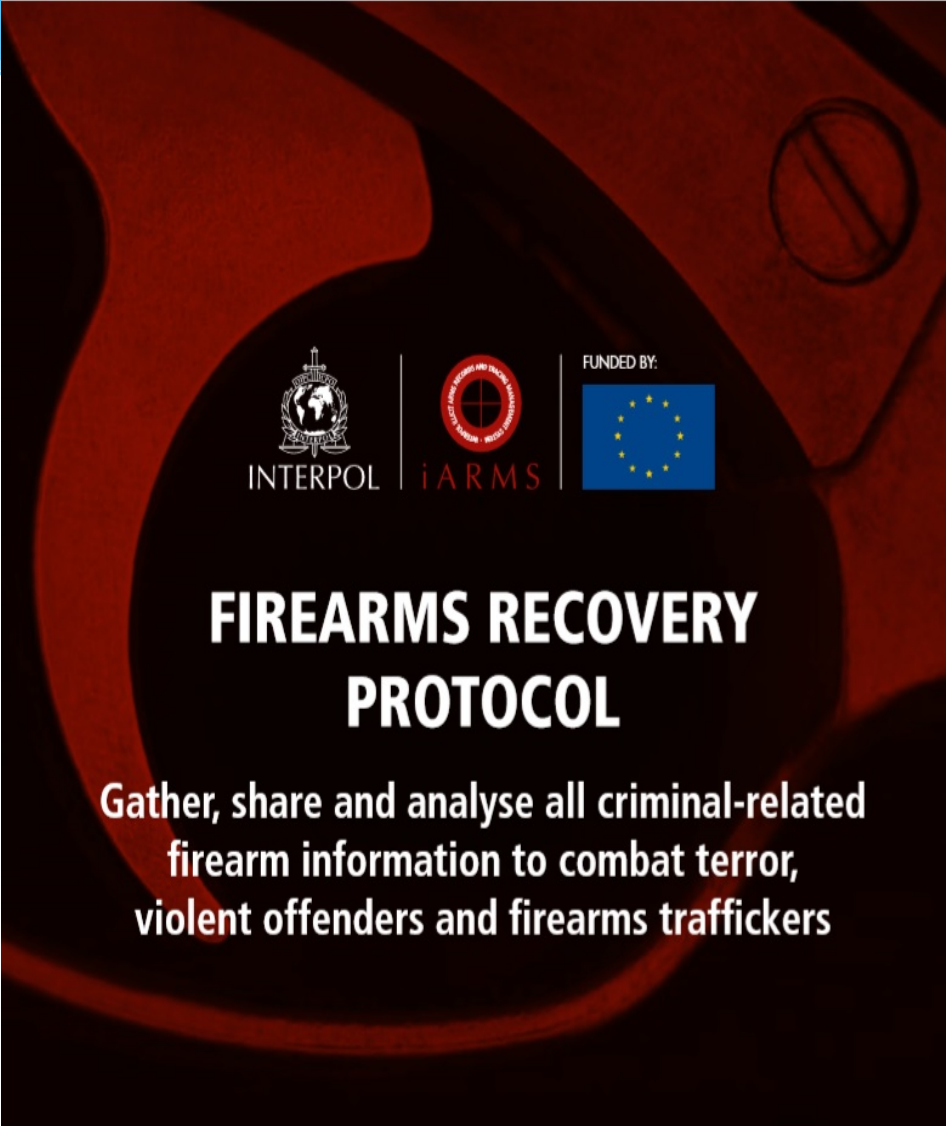

Training – Firearms Recovery Protocol

The image shows the cover of a manual titled 'FIREARMS RECOVERY PROTOCOL'. The background is a dark, abstract design with red and black tones, featuring a circular element that resembles a target or a lens. At the top, there are three logos: the INTERPOL logo (a globe with a crown), the iARMS logo (a red circle with a crosshair), and the European Union flag (a blue rectangle with yellow stars). Below the logos, the text 'FUNDING BY:' is visible. The main title 'FIREARMS RECOVERY PROTOCOL' is written in large, bold, white capital letters. Below the title, a subtitle in white text reads: 'Gather, share and analyse all criminal-related firearm information to combat terror, violent offenders and firearms traffickers'.

INTERPOL | iARMS | FUNDED BY: 

FIREARMS RECOVERY PROTOCOL

Gather, share and analyse all criminal-related firearm information to combat terror, violent offenders and firearms traffickers

Training – Component Parts

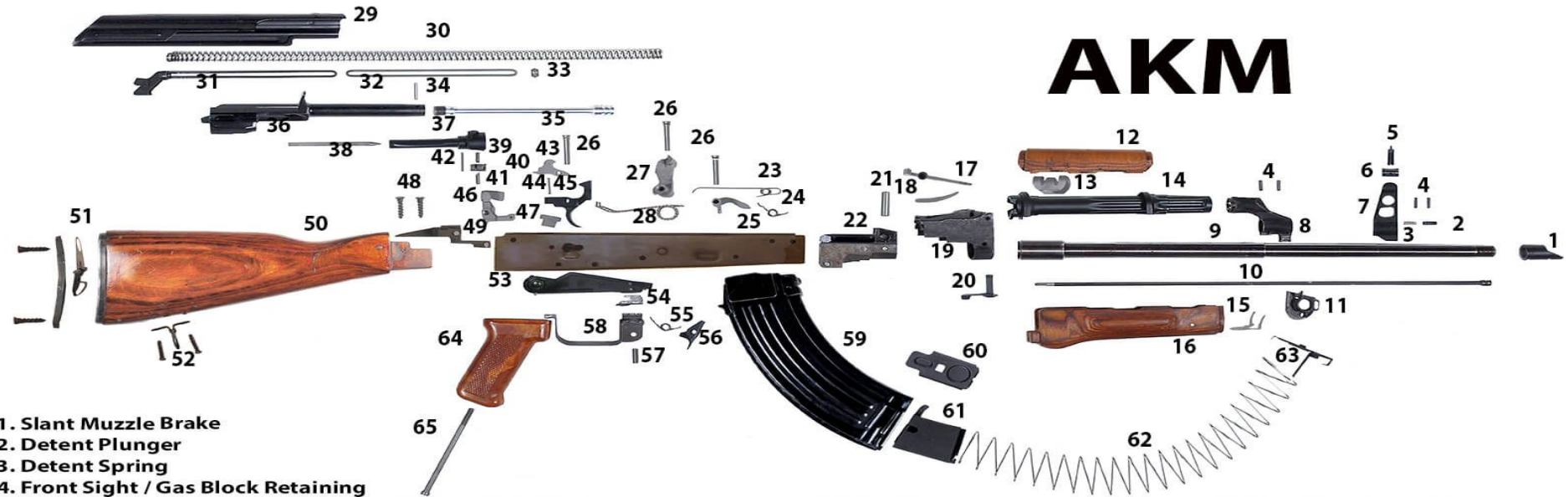

- 1. Slant Muzzle Brake
- 2. Detent Plunger
- 3. Detent Spring
- 4. Front Sight / Gas Block Retaining Pins
- 5. Front Sight Post
- 6. Front Sight Post Adjustment Base
- 7. Front Sight Block
- 8. Gas Block
- 9. Barrel
- 10. Cleaning Rod
- 11. Handguard Retainer
- 12. Upper Handguard
- 13. Handguard Retainer Spring
- 14. Gas Tube
- 15. Lower Handguard Tensioning Spring
- 16. Lower Handguard
- 17. Rear Sight Leaf
- 18. Rear Sight Leaf Spring

- 19. Rear Sight Block
- 20. Gas Tube Locking Lever
- 21. Barrel Retaining Pin
- 22. Front Trunnion
- 23. Full Auto Sear Spring
- 24. Full Auto Rate Reducer Spring
- 25. Receiver
- 26. Hammer, Trigger, Sear Axis Pin
- 27. Hammer
- 28. Hammer Spring
- 29. Dust Cover
- 30. Recoil Spring
- 31. Recoil Spring Rear Guide
- 32. Recoil Spring Front Guide
- 33. Recoil Spring Retainer
- 34. Bolt Carrier Assembly Rivet

- 35. Gas Piston
- 36. Bolt Carrier Body
- 37. Bolt Body
- 38. Bolt Body
- 39. Ejector Spring
- 40. Extractor
- 41. Extractor Retaining Pin
- 42. Firing Pin Retaining Pin
- 43. Full Auto Disconnecter
- 44. Disconnecter Spring
- 45. Trigger
- 46. Full Auto Rate Reducer
- 47. Pistol Grip Nut
- 48. Stock Screw
- 49. Fixed Stock Rear Trunnion
- 50. Fixed Stock

- 51. Butt Plate Assembly
- 52. Sling Swivel Assembly
- 53. Safety Selector Lever
- 54. Selector Stop
- 55. Magazine Catch Spring
- 56. Magazine Catch
- 57. Magazine Catch Retaining Pin
- 58. Trigger Guard
- 59. Magazine Body
- 60. Magazine Floor Plate
- 61. Magazine Follower
- 62. Magazine Spring
- 63. Magazine Follower Spring Base Plate
- 64. Pistol Grip
- 65. Pistol Grip Screw

Training - Safety

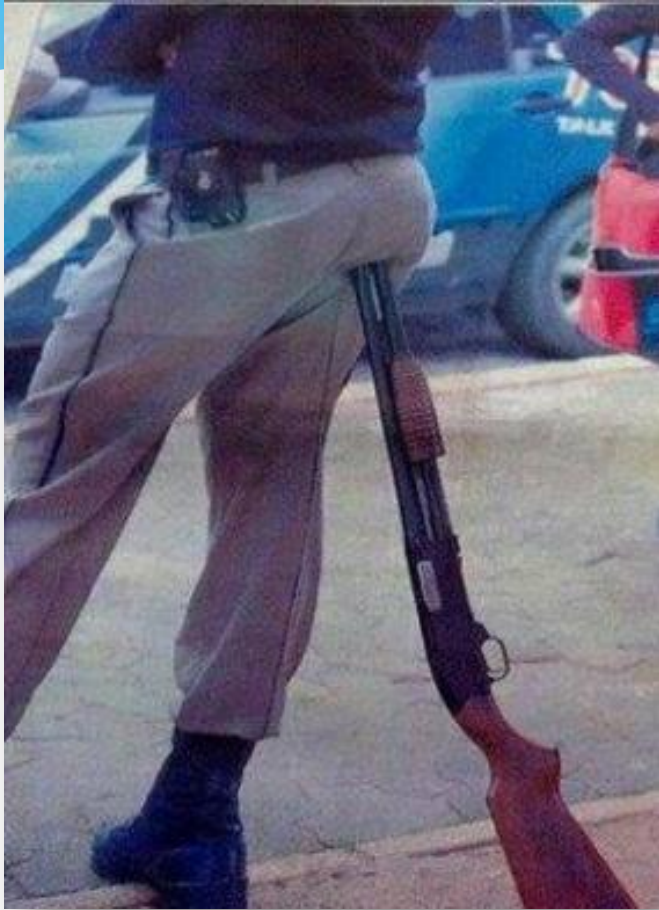



3rd Train the Trainer Sub Regional Event, Manila, Philippines, 1 -12 April, 2019

Training – Risk Assessment

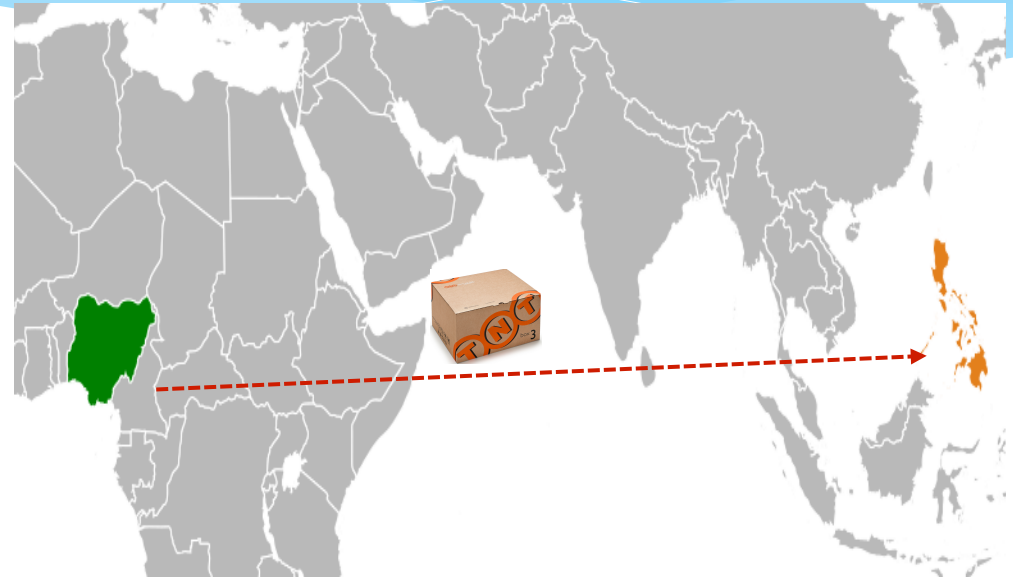

Training – Forensic Handling, Evidence



Training – Train the Trainer



1st Train the Trainer Sub Regional Event, Phnom Penh, Cambodia, 1 – 10 August, 2018.



3rd Train the Trainer Sub Regional Event, Manila, Philippines, 1 -12 April, 2019

National Training



National Training, Yogyakarta, Indonesia, 26 – 30 November, 2018

Online Learning



Welcome to this module

01_99_130



Small Arms, Light Weapons, Component Parts and Ammunition

These are your missions, should you choose to accept them. **Select your first mission.**

Investigate small
arms and light
weapons (SALW)



10 MINS



Examine component
parts

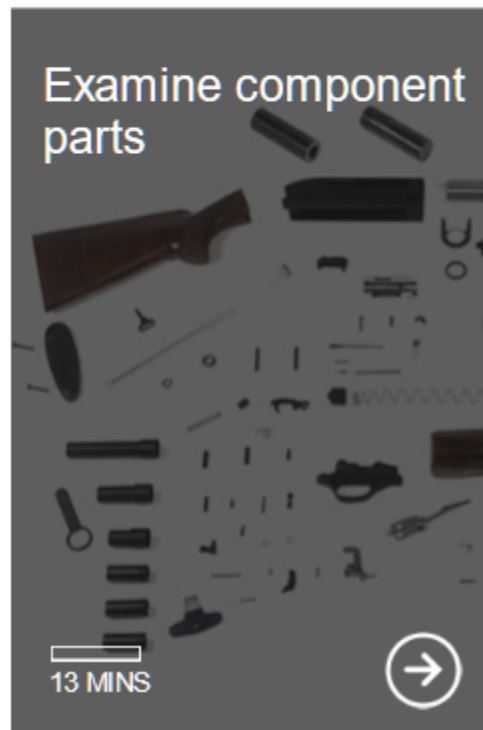

13 MINS



Inspect ammunition
and indicative
materials

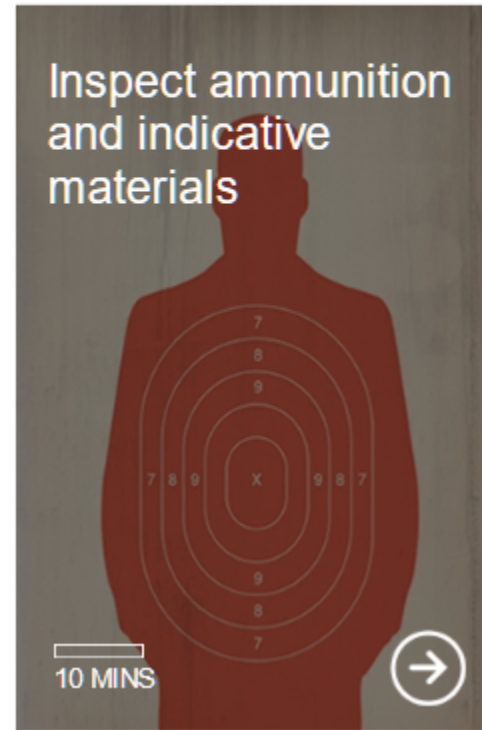

10 MINS



Procurement of Technical Equipment



HBI-120 Hand Held Backscatter X-Ray Device



Operations



WORLD CUSTOMS ORGANIZATION
ORGANISATION MONDIALE DES DOUANES

Joint Customs Operation

Small Arms and Light Weapons, Asia
Pacific Security Project

(SALW ASPS)

Operations

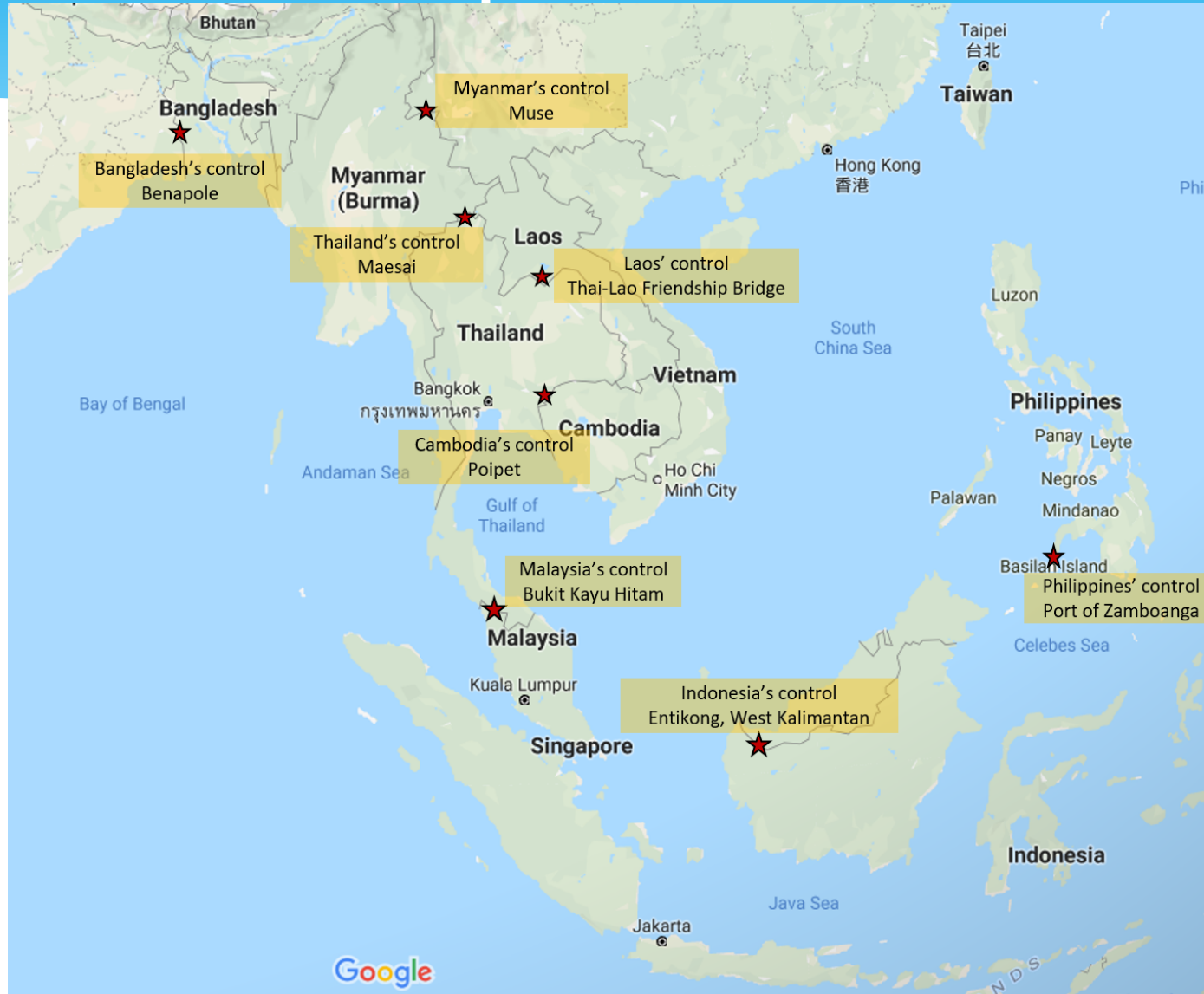

Summary

- * Sustainable Train the Trainer events
- * Procurement of Technical Equipment, Backscatter X-Ray
- * Joint Customs Operations